









Turbofan E27

Full Size Electric Convection Oven

-  3 tray capacity
(2 wire racks supplied)
-  Bi-directional reversing fan system
-  60 minute bake timer
-  Stainless steel exterior
-  Insulated easy clean vitreous interior
-  Toughened twin pane glass door
-  Internal lighting
-  Mechanical thermostat variable
between 50°C and 250°C
-  Drop down door



Turbofan E27



Turbofan E27

Full Size Electric Convection Oven

CONSTRUCTION

Stainless steel top and sides
Porcelain oven interior
Toughened twin pane door glass
Strong and stylish door handle
3 full pan capacity (2 wire racks included)
Fully insulated
Porcelain control panel
Fully enclosed motor at rear

CONTROLS

On/off switch
Mechanical thermostat, variable
between 50°C and 250°C
Bi-directional reversing fan system
Oven light
60 minute bake timer

CLEANING AND SERVICING

Fully removable racks and fan baffle
Easy clean surfaces
Access to all controls from front panel
No tools to replace lamps
Removable gaskets - no tools required

SPECIFICATIONS

Electrical requirements

220-240V, 50/60Hz, 1P+N+E, 3.0kW, 12.5A

External Dimensions

Width 945mm
Height 430mm
Depth 725mm

Internal Dimensions

Width 695mm
Height 285mm
Depth 505mm

Oven Volume

0.10m³

Oven Rack Dimensions

Depth 460mm
Width 660mm

Nett Weight

59kg

Packing Data

103kg
0.46m³
Width 985mm
Height 560mm
Depth 840mm

MOFFAT

www.moffat.com.au

Australia
Moffat Pty Limited

Victoria/Tasmania
740 Springvale Road
Mulgrave, Victoria 3170
Telephone 03-9518 3888
Facsimile 03-9518 3833
Email vsales@moffat.com.au
www.moffat.com.au

New South Wales
Telephone 02-8833 4111
Email nswsales@moffat.com.au

South Australia
Telephone 08-8274 2116
Email dmiller@moffat.com.au

Queensland
Telephone 07-3630 8600
Email qldsals@moffat.com.au

Western Australia
Telephone 08-9562 0263
Email jberent@moffat.com.au

New Zealand
Moffat Limited

Christchurch
Telephone 03-389 1007
Email sales@moffat.co.nz
www.moffat.co.nz

Auckland
Telephone 09-574 3150
Email sales@moffat.co.nz

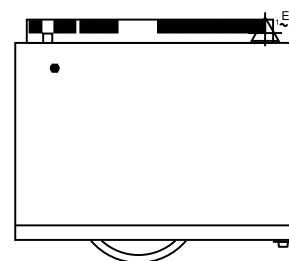
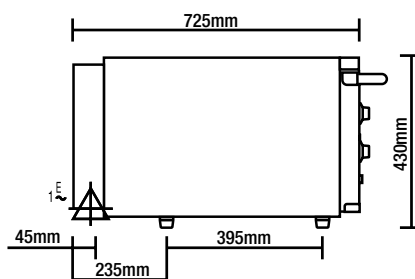
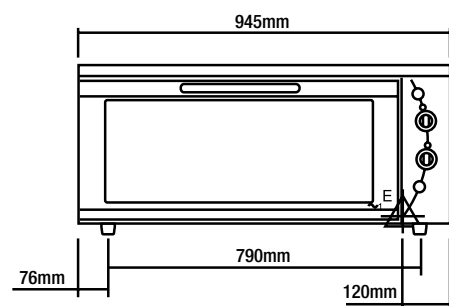

DOOR SWING 337mm

Turbofan E27



ISO 9001

All Turbofan products are designed and manufactured by Moffat Ltd using the internationally recognised ISO 9001 quality management system, covering design, manufacture and final inspection, ensuring consistent high quality at all times.

